

**Pump specifications:**

Type.....	B30-180 BVGMC
Max. flow .....	32 m <sup>3</sup> /hour
Max. head .....	39 mwc
Connections.....	Suction 2" – Discharge 1-1/2"
Impeller type .....	Semi-open impeller
Free passage.....	12 mm
Pump speed .....	2850 rpm
Electric motor.....	4 kW - 2 pole
Voltage .....	400/690V IE2
Assembly .....	Monobloc
Weight (net).....	85 kg

**FEATURES**

**B self-priming centrifugal pump**

The B range of pumps have been designed with a clear focus on reliability, efficiency and durability, ranging from 1-1/2" to 12". Featuring an open impeller configuration in combination with a changeable wear plate, facilitating servicing and minimising costs of spares. All B series pumps are fitted with a non return valve in the suction port, eliminating the need for a foot valve in suction line and allowing quick priming.

**Design features**

- Basic, reliable technology
- Large solids handling capacity
- Suitable for use with hot fluids
- Cooled shaft seal
- Extended life due to pump design
- Available with ATEX approval

**Fields of application**

- Shipping
- Industry
- Construction
- Waste water management
- Emergency pump units
- Irrigation
- Agriculture
- Horticulture

**Complete package designed & built by BBA Pumps**

- Complete in-house design & production
- Over 60 years of experience in the market
- Extensive testing facility in-house
- Contemporary & functional design
- Durable & eco-friendly materials
- Custom builds available

**After sales service & product support**

- Single supplier for parts, spares & accessories
- Dedicated customer help-desk (24h service)
- Dedicated service department in-house
- Global parts distribution network
- Optional global on-site servicing
- Extensive training options available (technical & commercial), on-site or in-house

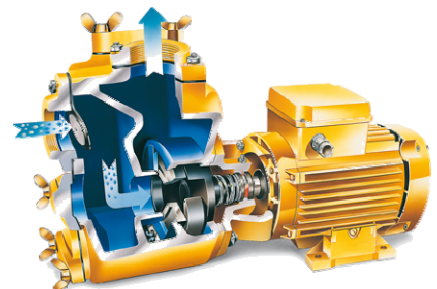

**PERFORMANCE CURVES (2900 RPM)**

Continuous duty according ISO 9906

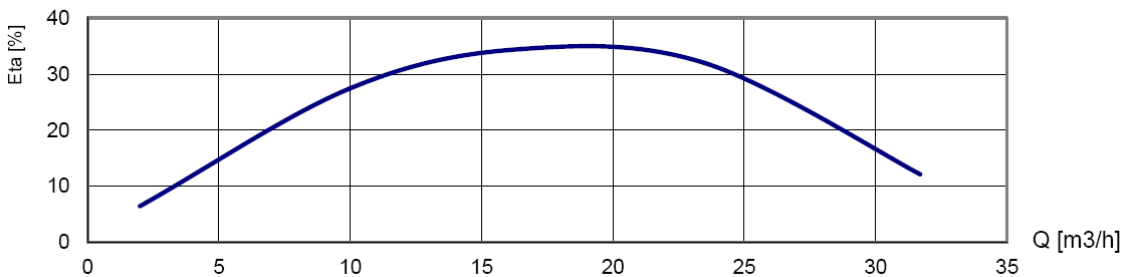
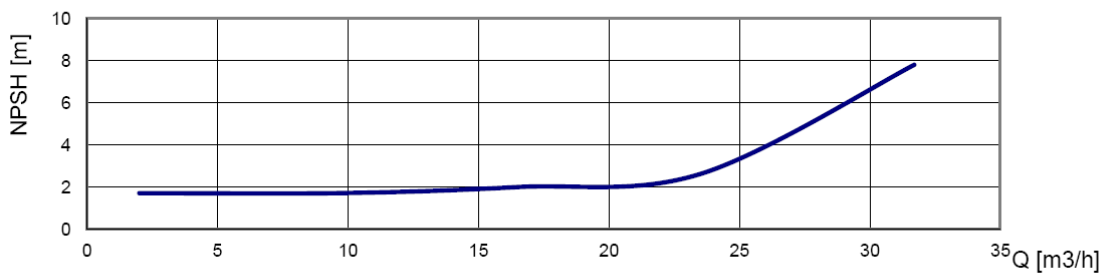
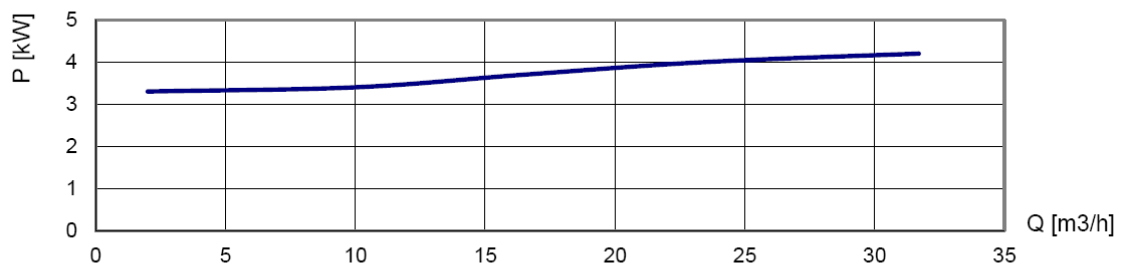
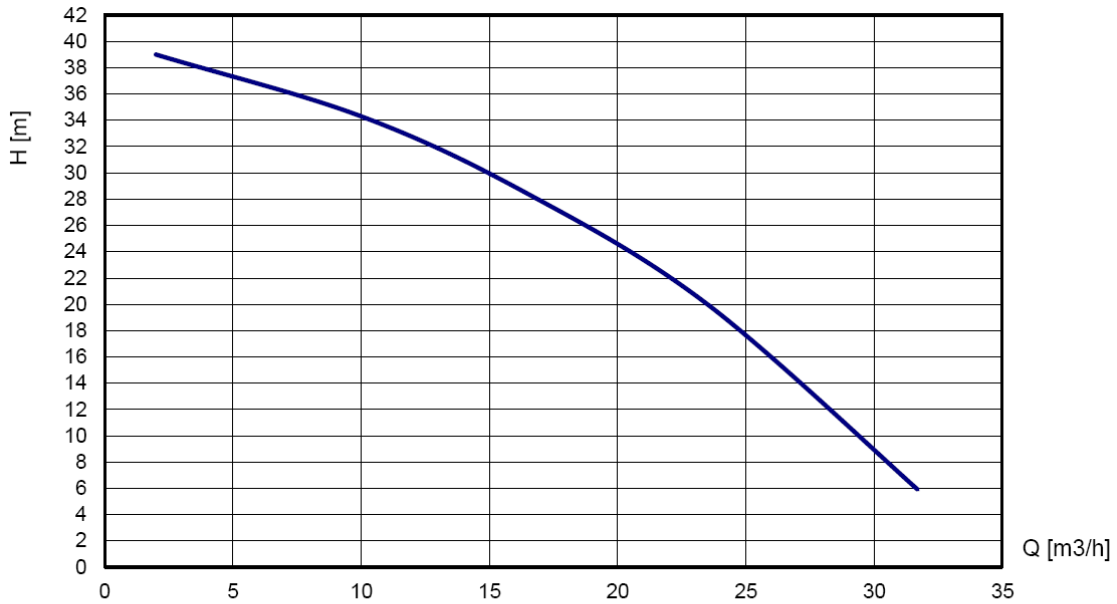

**STANDARD TECHNICAL SPECIFICATIONS**

**BBA centrifugal pump**

Model..... B30-180 BVGMC  
Max. flow..... 32 m<sup>3</sup>/hour  
Max. head..... 39 mwc  
Free passage..... 12 mm  
Pump speed..... 2900 rpm  
Connections..... Suction 2" – Discharge 1,5" BSP

**Materials**

Pump casing ..... Cast iron GG20 – 0.6020  
Wear plate..... Cast iron GG20 – 0.6020  
Impeller..... Cast iron GG20 – 0.6020  
Shaft seal ..... Mechanical seal  
Seal faces ..... Sic / Sic / Viton  
Pump shaft..... Steel C45 – 1.1191  
Gaskets..... NBR / paper

**Electric motor**

Power..... 4 kW – 2 pole  
Voltage..... 400/690 V  
Frequency..... 50 Hz  
Mounting..... B3/B14A, IP55, ISO F  
Assembly ..... Monobloc

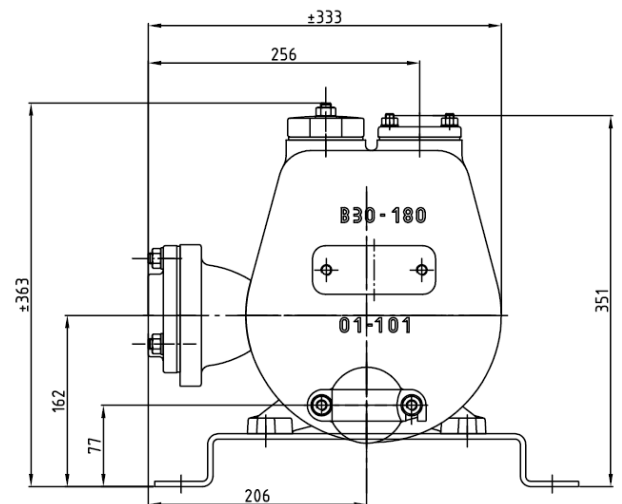
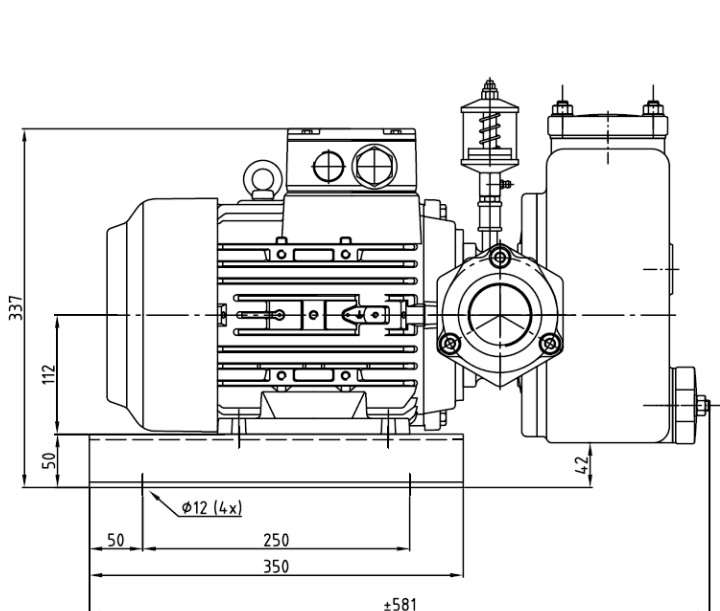

**OPTIONAL FEATURES**

**Mechanical seals**

T3W seal..... HM / HM / Viton  
MG1 seal ..... Sic / Sic / EPDM

**Gaskets**

N NBR: Perbunan  
V FPM: Viton  
E EPDM  
T PTFE: Teflon  
K FFKM, Kalrez

**Extras**

+F ..... DIN flanges  
+FK..... DIN flanges, stainless steel 316  
+BI..... Bronze impeller; stainless steel 316 shaft  
+BII..... Bronze impeller/wear plate, stainless steel 316 shaft  
+KI..... Stainless steel 316 impeller and shaft  
+KII..... Stainless steel impeller, wear plate and shaft  
+M ..... N/A  
+P ..... Perma grease cartridge  
+VP ..... Grease glass for seal lubrication  
+KW .... Wheelbarrow frame  
60Hz..... N/A